

7000 Drawn and Conservation and 7100 Folding and Integral Max-Emerge[®] Planters



TECHNICAL MANUAL

7000 Drawn and Conservation and 7100 Folding and
Integral Max-Emerge[®] Planters

TM1154 (01APR82) English

John Deere Harvester Works
TM1154 (01APR82)

LITHO IN U.S.A.
ENGLISH



7000 DRAWN AND CONSERVATION AND 7100 FOLDING AND INTEGRAL MAX-EMERGE® PLANTERS TECHNICAL MANUAL TM-1154 (Apr-82)

CONTENTS—REPAIR SECTIONS

- | | |
|--|---|
| SECTION 10 - GENERAL | SECTION 110 - PLANTING UNIT REPAIR |
| Group 00 - Specifications | Group 05 - Seed Metering Mechanisms |
| Group 05 - Predelivery, Delivery Service, and
After-Sale Services | Group 10 - Seed Openers |
| Group 10 - Lubrication | Group 15 - Closing Wheels |
| SECTION 70 - HYDRAULIC REPAIR | SECTION 120 - DISK MARKER REPAIR |
| Group 00 - Specifications | Group 00 - Specifications |
| Group 05 - 7000 Planter Systems (Excluding
Markers) | Group 05 - Marker Actuator and Cables
(7000 and 7100 Integral Frame
Planters) |
| Group 10 - 7100 Planter Systems (Excluding
Markers) | Group 10 - Marker Control (7100 Folding Planter) |
| Group 15 - Marker Cylinders | Group 15 - Marker Arms |
| SECTION 100 - DRIVES REPAIR | |
| Group 00 - Specifications | |
| Group 05 - Drive Wheels | |
| Group 10 - Countershaft Drive System | |
| Group 15 - Seed Drive Transmission | |
| Group 20 - Dry Fertilizer Drive | |
| Group 25 - Liquid Fertilizer Drive | |

CONTENTS—OPERATION AND TEST SECTIONS

- | | |
|---|--|
| SECTION 270 - HYDRAULIC OPERATION AND
TEST | SECTION 320 - DISK MARKER OPERATION
AND TESTS |
| Group 00 - Specifications | Group 00 - Specifications |
| Group 05 - Operation | Group 05 - Marker Actuator and Cables (7000 and
7100 Integral Frame Planters) |
| Group 10 - Testing | Group 10 - Hydraulic Markers |
| SECTION 310 - PLANTING UNITS OPERATION
AND TESTS | Group 15 - Marker Disk |
| Group 05 - Seed Metering Mechanisms | |
| Group 10 - Seed Openers | |
| Group 15 - Closing Wheels | |
| Group 20 - Checking Row Unit Meters
with Run-In Unit | |
| Group 25 - Checking Population | |

All information, illustrations and specifications contained in this technical manual are based on the latest information available at the time of publication. The right is reserved to make changes at any time without notice.

Because John Deere sells its products world-wide, U.S. units of measure are shown with their respective Metric equivalents throughout this technical manual. These equivalents are the SI (International System) Units of Measure.

NOTE: Monitor Section 130 and 330 have been removed from this manual. Refer to TM-1270 for ALL planter monitoring system information.

Copyright © 1982
DEERE & COMPANY
Moline, Illinois
All rights reserved
Previous Editions

Copyright © 1981 Deere & Company
Copyright © 1980 Deere & Company
Copyright © 1978 Deere & Company

INTRODUCTION

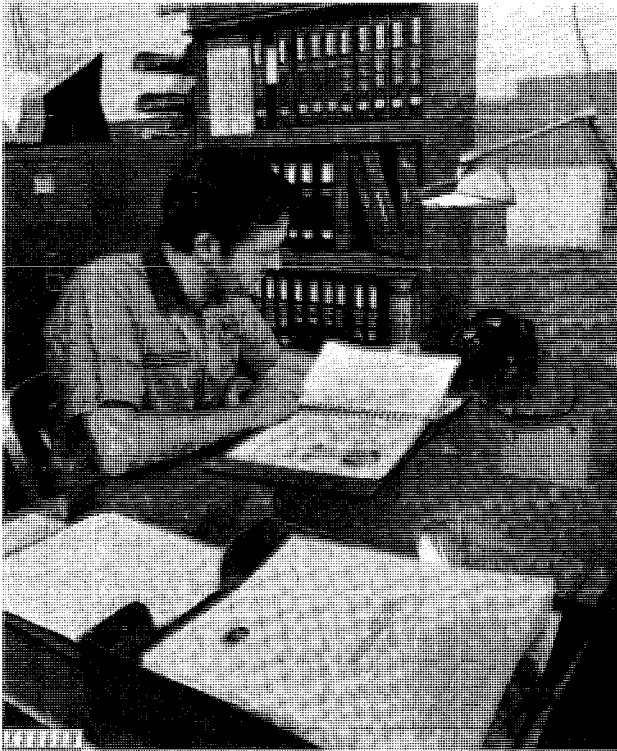

Use FOS Manuals for Reference

This technical manual is part of a twin concept of service:

- **FOS Manuals—for reference**
- **Technical Manuals—for actual service**

The two kinds of manuals work as a team to give you both the general background and technical details of shop service.

Fundamentals of Service (FOS) Manuals cover basic theory of operation, *fundamentals* of trouble shooting, *general* maintenance, and *basic* types of failures and their causes. FOS Manuals are for training new people and for reference by experienced technicians.

Technical Manuals are *concise* service guides for a *specific* machine. Technical manuals are on-the-job guides containing only the vital information needed by an experienced technician.

NOTE: Whenever the service technician may need to refer to a FOS Manual for additional information, a specific manual, chapter and/or page number is given.



Use Technical Manuals for Actual Service

Some features of this technical manual:

- *Table of contents at front of manual*
- *Exploded views showing parts relationship*
- *Photos showing service techniques*
- *Specifications grouped for easy reference*

This technical manual was planned and written for you—an experienced technician. Keep it in a permanent binder in the shop where it is handy. Refer to it whenever in doubt about correct service procedures or specifications.

Using the technical manual as a guide will reduce error and costly delay. It will also assure you the best in finished service work.

 This safety alert symbol identifies important safety messages in this manual. When you see this symbol, be alert to the possibility of personal injury and carefully read the message that follows.

**Thanks very much for your reading,
Want to get more information,
Please click here, Then get the complete
manual**

JustClickHere 

NOTE:

**If there is no response to click on the link above,
please download the PDF document first, and then
click on it.**

**Have any questions please write to me:
admin@servicemanualperfect.com**

SAFETY AND YOU



T27999N

INTRODUCTION

 This safety alert symbol identifies important safety messages in this manual and on the planter. When you see this symbol, be alert to the possibility of personal injury and carefully read the message that follows.

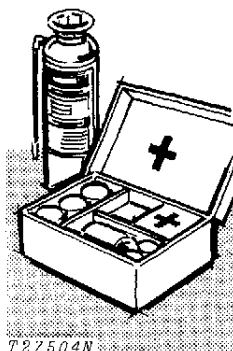

T27504N

Be prepared if an accident or fire should occur. Know where the first aid kit and the fire extinguishers are located—know how to use them.

SERVICE AREA

Keep the service area clean and dry. Wet or oily floors are slippery. Wet spots can be dangerous when working with electrical equipment.

Make sure the service area is adequately vented.

Be sure all electrical outlets and tools are properly grounded.

Use adequate light for the job at hand.

SERVICE

Always lower the planter to the ground when not in use. Whenever possible, perform service work and adjustments with the planter on the ground.

Never clean, lubricate, or adjust a machine that is in motion.

TRANSPORTING

Always lock markers in transport position before transporting the planter any considerable distance.

Stand clear of disk blade when raising or securing marker.

When transporting the planter on a smooth surface road, do not exceed maximum tractor transport speed. Reduce speed considerably when traveling over rough ground.

When transporting the planter on a road or highway at night or during the day, use accessory lights and devices for adequate warning to operators of other vehicles. In this regard, check local governmental regulations. Various safety lights and devices are available from your John Deere dealer.

FLUIDS UNDER PRESSURE

Escaping fluid under pressure can have sufficient force to penetrate the skin, causing serious personal injury. Before disconnecting lines, be sure to relieve all pressure. Before applying pressure to the system, be sure all connections are tight and that lines, pipes and hoses are not damaged. Fluid escaping from a very small hole can be almost invisible. Use a piece of cardboard or wood, rather than hands, to search for suspected leaks.

If injured by escaping fluid, see a doctor at once. Serious infection or reaction can develop if proper medical treatment is not administered immediately.

Always relieve pressure in the hydraulic system before working with hydraulic system components.

When checking hydraulic pressure, be sure to use the correct test gauge for the pressure in the particular system.

PERSONAL SAFETY

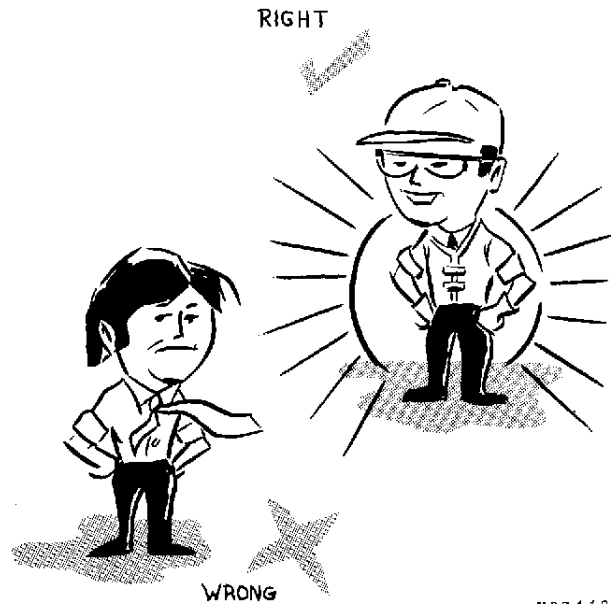

Always avoid loose clothing or any accessory—flopping cuffs, dangling neckties and scarves—that can catch in moving parts and put you out of work. Always wear your safety glasses while on the job.

Section 10 GENERAL

CONTENTS OF THIS SECTION

	Page		Page
GROUP 00 - SPECIFICATIONS		GROUP 05 - PREDELIVERY, DELIVERY	
Description	00-1	SERVICE, AND AFTER-SALE	
Serial Numbers	00-1	SERVICES	
Oil Capacity of Hydraulic Systems	00-2	Predelivery Service	05-1
Acres per Hour for Various		Delivery Service	05-5
Machine Sizes	00-3	After-Sale Services	05-5
		GROUP 10 - LUBRICATION	

Group 00 SPECIFICATIONS

DESCRIPTION

All Max-Emerge Planters have tubular steel frames. The 7000 4-row narrow, 4-row wide, and 6-row narrow machines have 5- x 7-inch (127 mm x 178 mm) frames; the 6-row wide, 8- and 12-row have 7- x 7-inch (178 x 178 mm) frames. The 7000 Conservation Planters and all 7100 Planters have 7- x 7-inch (178 mm x 178 mm) frames.

"Right-hand" and "left-hand" sides are determined by facing in the direction the planter will travel when in use.

SERIAL NUMBERS

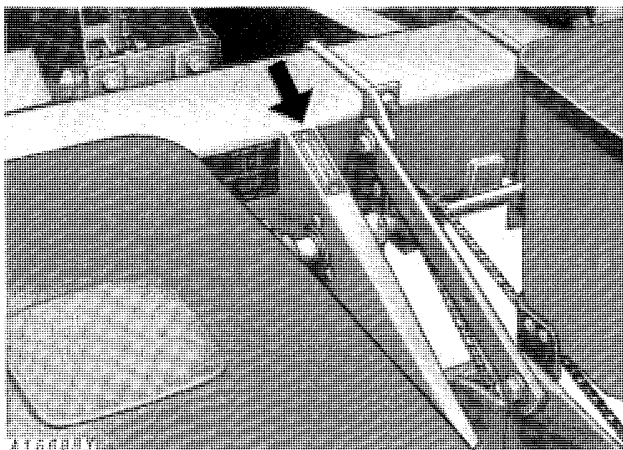

Fig. 1-Serial Number Plate Location

The 7000 or 7100 Max-Emerge Planter (except 22-inch row spacing) has a serial number located on the top right side of the seed drive transmission (Fig. 1).

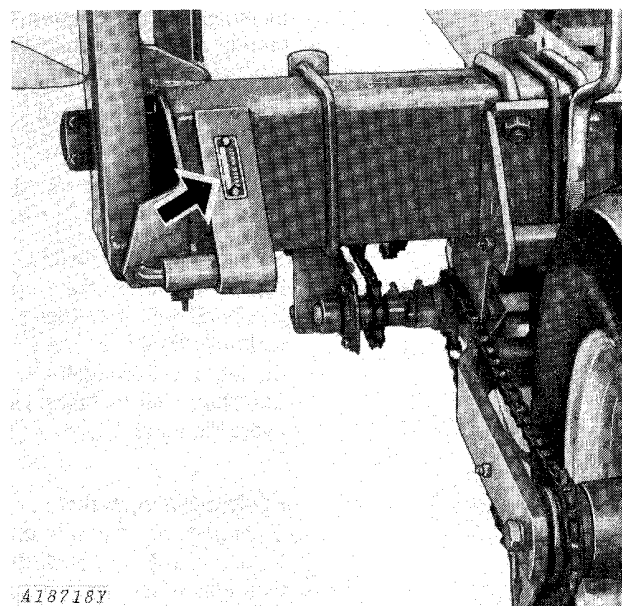

Fig. 2-Serial Number Plate Location

On 7100 Integral Max-Emerge Planters with 22-inch row spacing, the serial number is located on the right hand side on the end of the frame (Fig. 2).

OIL CAPACITY OF HYDRAULIC SYSTEMS

(Quantities given represent volume of oil contained in planters raised to field transport position.)

7000 Planters

4-Row Narrow, 4-Row Wide, or 6-Row Narrow	-Includes a 3-1/2- x 8-inch (76.2 mm x 203.2 mm) tractor cylinder, marker cylinders, manifold, and all hoses	4 U.S. Pts.	(1.8 L)
6-Row Wide, 8-Row Narrow, or 8-Row Wide	-Includes master cylinder, slave cylinders, marker cylinders, manifolds, and all hoses	12 U.S. Pts.	(5.7 L)
12-Row Narrow	-Includes master cylinder, slave cylinders, marker cylinders, manifolds, and all hoses	16 U.S. Pts.	(7.6 L)

7000 Conservation Planters

4-Row, 30- to 40-inch (76 cm to 101 cm) Rows	-Includes wheel frame cylinders, marker cylinder, manifold and all hoses	6 U.S. Pts.	(2.9 L)
6-Row Narrow	-Includes wheel frame cylinders, marker cylinder, manifold and all hoses	11-1/2 U.S. Pts.	(5.4 L)
6-Row Wide, 8-Row Narrow	-Includes master cylinder, wheel frame cylinders, marker cylinder, manifold and all hoses	12 U.S. Pts.	(5.7 L)

7100 Planters - Integral Frame

4-Row Wide	-Equipped with markers	1 U.S. Pt.	(0.4 L)
	-Equipped with markers, single lift assist wheel, and hydraulic mast	5-1/2 U.S. Pts.	(2.7 L)
6-Row Narrow	-Equipped with markers	1 U.S. Pt.	(0.4 L)
	-Equipped with markers and single lift assist wheel	3-1/2 U.S. Pts.	(1.5 L)
	-Equipped with markers, single lift assist wheel, and hydraulic mast	6 U.S. Pts.	(2.9 L)
	-Equipped with markers and dual lift assist wheels	6-1/2 U.S. Pts.	(3.1 L)
6-Row Wide or 8-Row Narrow	-Equipped with markers, dual lift assist wheels, and hydraulic mast	8-1/2 U.S. Pts.	(4.0 L)
	-Equipped with markers	1 U.S. Pt.	(0.4 L)
	-Equipped with markers and dual lift assist wheels	6-1/2 U.S. Pts.	(3.1 L)
8-Row Wide or 12-Row Narrow	-Equipped with markers, dual lift assist wheels, and hydraulic mast	8-1/2 U.S. Pts.	(4.0 L)
	-Equipped with markers	2 U.S. Pts.	(0.9 L)
	-Equipped with markers and dual lift assist wheels	7-1/2 U.S. Pts.	(3.5 L)
	-Equipped with markers, dual lift assist wheels, and hydraulic mast	9-1/2 U.S. Pts.	(4.4 L)

7100 Planters - Folding Frame

8-Row Wide	-Equipped with markers	9-1/2 U.S. Pts.	(4.4 L)
	-Equipped with markers, single lift assist wheels, and hydraulic mast	14-1/2 U.S. Pts.	(6.8 L)
12-Row Narrow	-Equipped with markers	11-1/2 U.S. Pts.	(5.4 L)
	-Equipped with markers and dual lift assist wheels	17 U.S. Pts.	(8.0 L)
	-Equipped with markers, dual lift assist wheels, and hydraulic mast	19 U.S. Pts.	(9.0 L)

ACRES PER HOUR CAPABILITIES*

Machine Size	Speed in MPH										
	3	3-1/2	4	4-1/2	5	5-1/2	6	6-1/2	7	7-1/2	8
4-Row 30"	3-3/4	4-1/4	5	5-1/2	6-1/4	6-3/4	7-1/2	8-1/4	8-3/4	9-1/4	10
32"	4	4-1/2	5-1/4	6	6-1/2	7-1/4	8	8-1/2	9-1/4	10	10-1/2
34"	4-1/4	5	5-1/2	6-1/4	7	7-3/4	8-1/2	9	10	10-1/2	11-1/4
36"	4-1/2	5-1/4	6	6-3/4	7-1/2	8-1/4	9	9-3/4	10-1/2	11-1/4	12
38"	4-3/4	5-1/2	6-1/4	7	8	8-1/2	9-1/2	10-1/4	11	11-3/4	12-1/2
40"	5	5-3/4	6-1/2	7-1/2	8-1/4	9	10	10-3/4	11-1/2	12-1/2	13-1/4
6-Row 30"	5-1/2	6-1/2	7-1/2	8-1/4	9-1/4	10-1/4	11-1/4	12	13	14	15
36"	6-3/4	7-3/4	9	10	11-1/4	12-1/4	13-1/2	14-1/2	15-3/4	16-3/4	18
38"	7	8-1/4	9-1/2	10-1/2	11-3/4	13	14-1/4	15-1/4	16-1/2	17-3/4	19
40"	7-1/2	8-3/4	10	11-1/4	12-1/2	13-3/4	15	16-1/4	17-1/2	18-3/4	20
8-Row 30"	7-1/2	8-3/4	10	11-1/4	12-1/2	13-3/4	15	16-1/4	17-1/2	18-3/4	20
36"	9	10-1/2	12	13-1/2	15	16-1/2	18	19-1/2	21	22-1/2	24
38"	9-1/2	11	12-1/2	14-1/4	15-3/4	17-1/4	19	20-1/2	22	23-3/4	25-1/4
40"	10	11-1/2	13-1/4	15	16-1/2	18-1/4	20	21-1/2	23-1/4	25	26-1/2
12-Row 22"	8-1/4	9-1/2	11	12-1/4	13-3/4	15	16-1/4	17-3/4	19-1/4	20-1/2	22
30"	11-1/4	13	15	16-3/4	18-3/4	20-1/2	22-1/2	24-1/4	26-1/4	28	30

HECTARES PER HOUR CAPABILITIES*

Machine Size	Speed in Kilometres per Hour										
	4	5	6	7	8	9	10	11	12	13	
4-Row 76 cm	1.3	1.6	1.9	2.2	2.5	2.8	3.2	3.5	3.8	4.1	
81 cm	1.3	1.7	2.0	2.4	2.7	3.0	3.4	3.8	4.0	4.4	
86 cm	1.4	1.8	2.2	2.5	2.9	3.2	3.6	3.9	4.3	4.7	
91 cm	1.5	1.9	2.3	2.7	3.0	3.4	3.8	4.2	4.6	4.9	
97 cm	1.6	2.0	2.4	2.8	3.2	3.6	4.0	4.4	4.8	5.2	
102 cm	1.7	2.1	2.5	3.0	3.4	3.8	4.2	4.6	5.1	5.5	
6-Row 76 cm	1.9	2.4	2.8	3.3	3.8	4.3	4.7	5.2	5.7	6.2	
91 cm	2.3	2.8	3.4	4.0	4.6	5.1	5.7	6.3	6.8	7.4	
97 cm	2.4	3.0	3.6	4.2	4.8	5.4	6.0	6.6	7.2	7.8	
102 cm	2.5	3.2	3.8	4.4	5.1	5.7	6.3	7.0	7.6	8.2	
8-Row 76 cm	2.5	3.2	3.8	4.4	5.1	5.7	6.3	7.0	7.6	8.2	
91 cm	3.0	3.8	4.6	5.3	6.1	6.8	7.6	8.3	9.1	9.9	
97 cm	3.2	4.0	4.8	5.6	6.4	7.2	8.0	8.8	9.6	10.4	
102 cm	3.4	4.2	5.1	5.9	6.7	7.6	8.4	9.3	10.1	11.0	
12-Row 56 cm	2.8	3.4	4.1	4.8	5.6	6.2	7.0	7.6	8.4	9.0	
76 cm	3.8	4.7	5.7	6.6	7.6	8.5	9.5	10.4	11.4	12.3	

*NOTE: Acres (Hectare) per hour capabilities do not reflect time for turning at field ends or for filling hoppers.

Group 05

PREDELIVERY, DELIVERY, AND AFTER-SALE SERVICES

PREDELIVERY SERVICE

The John Deere Delivery Receipt, when properly filled out and signed by the dealer and customer, verifies that the predelivery and delivery services were satisfactorily performed. When delivering this machine, give the customer a copy of the delivery receipt and the operator's manual. Explain their purpose.

Because of the shipping factors involved, plus extra finishing touches that are necessary to promote customer satisfaction, proper predelivery service is of prime importance to the dealer.

After completing the factory-recommended dealer checks and services listed on the predelivery insert page, remove the page from the operator's manual and file it with the shop order for the job. The page will certify that the planter has received the proper predelivery service when that portion of the customer's John Deere Delivery Receipt is completed.

TORQUE CHART

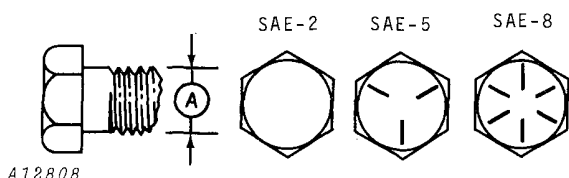

Bolt Diameter "A"	Bolt Torque in Ft-Lbs (Nm) (kgm)								
	SAE 2			SAE 5			SAE 8		
3/8"	23 (31)	(3.1)	35 (47)	(4.7)	50 (68)	(6.8)			
7/16"	35 (47)	(4.7)	55 (75)	(7.5)	80 (108)	(10.8)			
1/2"	55 (75)	(7.5)	85 (115)	(11.5)	120 (163)	(16.3)			
9/16"	75 (102)	(10.2)	130 (176)	(17.6)	175 (237)	(23.7)			
5/8"	105 (142)	(14.2)	170 (231)	(23.1)	240 (325)	(32.5)			
3/4"	185 (251)	(25.1)	300 (407)	(40.7)	425 (576)	(57.6)			
7/8"	160 (217)	(21.7)	445 (603)	(60.3)	685 (929)	(92.9)			
1"	250 (339)	(33.9)	670 (910)	(91.0)	1030 (1396)	(139.6)			
1-1/4"	330 (450)	(45.0)	910 (1235)	(123.5)	1460 (1979)	(197.9)			

NOTE: Bolts having lock nuts should be tightened to approximately 50% of amounts shown in above chart.

Machine bolts and cap screws 7/8-inch and larger are sometimes formed hot rather than cold, which accounts for the lower torque.

Planter Main Frame

Check clutch strap for proper assembly (4-Row Narrow, 4-Row Wide, or 6-Row Narrow Drawn Planters).

Check drive wheels to be certain they are assembled properly and that they turn without binding.

Be certain chain guards and shields are properly installed on appropriate sizes and applications.

Be certain that chain idlers pivot freely.

Check all chains for proper tension.

Check all grease fittings to be certain none have been broken off in shipment.

Lubricate the planter as outlined in Section 10, Group 15.

Be certain planter tires are properly inflated.

Check all hardware to be certain it is tight. See torque chart at left.

Paint any parts which may have become scratched or faded during storage or shipment. Replace any damaged decals.

Raise and lower the planter to be certain planter lift system is working properly, and to be sure that there are no interferences.

Markers

Set proper cable tension.

Raise and lower to check rate of raise and rate of drop.

Be certain markers alternate properly.

Adjust markers to row width desired by customer.

Planting Units

Inspect unit seed meters (finger pickup, feed cup, plate hopper bottom) for proper fit, assembly, and adjustment.

Check hopper drives for proper alignment.

Be sure chain idlers pivot freely and that chains have proper tension.

Attachments

Be certain attachments are properly assembled.

Check for any interference when planter is raised or lowered.

Be certain that herbicide brackets will trip rearward.

Be sure that fertilizer augers are centered on shafts on all but 4-Row Narrow 7000 Planters. (On 4-Row Narrow, they must be offset 1-1/8" [28 mm]).

Be certain fertilizer augers are centered in hopper.

General

Be certain to run-in planter as described under RUN-IN PROCEDURE, to check for unusual noises, proper chain alignments, excessive part wear, and that all drives are turning properly without binding.

PLANTER RUN-IN

Run-In Unit Assembly

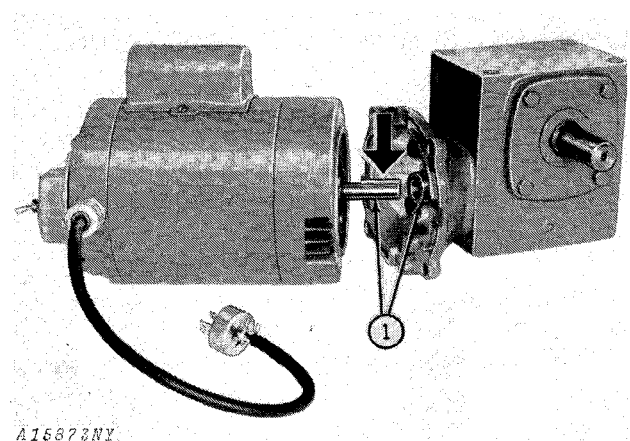

Fig. 1-Motor and Reducer

1. Align key on motor shaft with keyway in gear reducer and install run-in motor shaft in gear reducer.

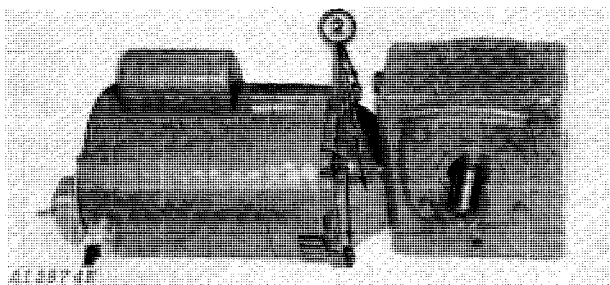

Fig. 2-Motor-Reducer Assembly

2. Bolt run-in unit motor to gear reducer as shown.

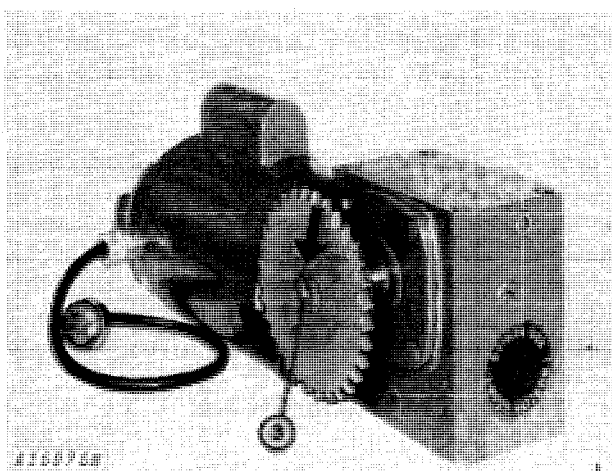
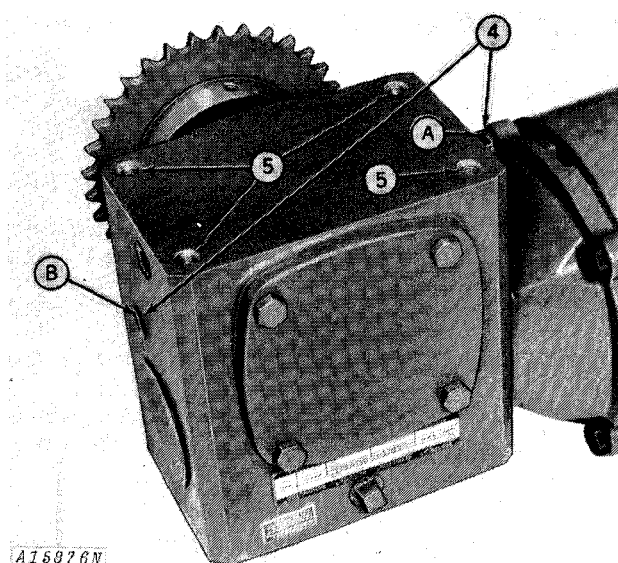

Fig. 3-32-Tooth Drive Sprocket

3. Install 32-tooth sprocket and key on gear reducer shaft.



A—Oil Filler Vent Plug

B—Oil Level Plug

Fig. 4-Oil Plugs

4. Remove oil filler vent plug (A, Fig. 4) and oil level plug (B) from gear reducer.

NOTE: Gear reducer is shipped without oil.

Fill gear reducer with SAE 90 oil at "A" until oil runs out oil level hole at "B."

5. Remove plugs from gear reducer.

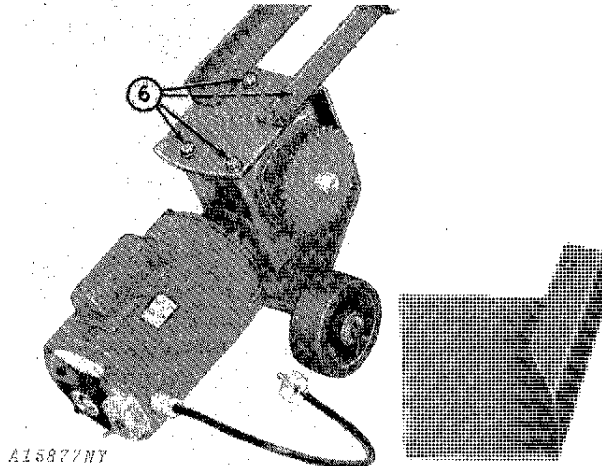

Fig. 5-Attaching Frame

6. Install 7000 or 7100 run-in unit frame on gear reducer as shown.

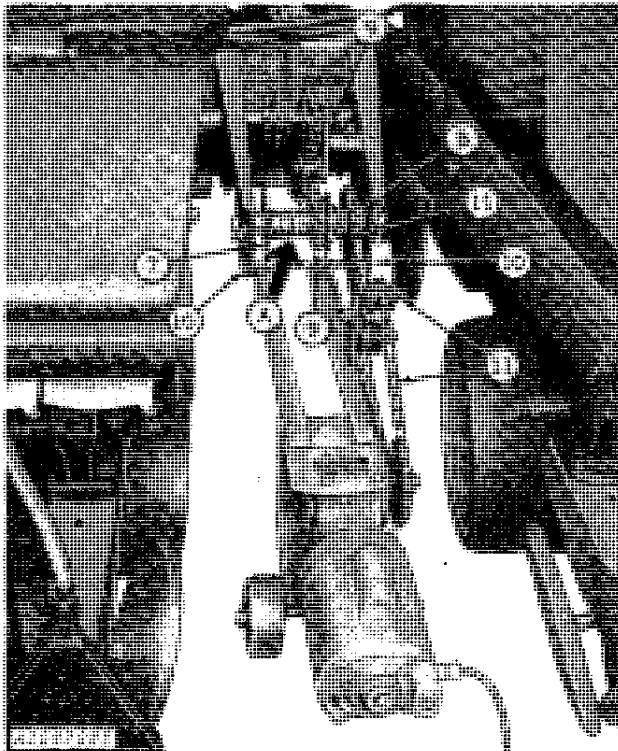

Fig. 6-Sprocket and Chain Assembly

7. Remove the roller chain from the countershaft to lower shaft sprockets.

NOTE: On 6-row wide, 8- and 12-row 7000 Planters, the countershaft chain is on the right-hand side of the transmission.

8. (4-row and 6-row narrow 7000 Planters and 7100 Planters) Loosen chain tightener and move double sprocket (8- and 15-tooth cast or 16- and 30-tooth steel) to right-hand side of transmission.

Position rubber sprocket spacers (A, Fig. 6) as shown.

9. Secure planter drive chain to 11-tooth cast or 22-tooth steel driver and 14-tooth cast or 28-tooth steel driven sprockets with chain tightener.

10. Position run-in unit between transmission panels and attach to panels with drilled pin, washers, and spring locking pins.

11. Install chain on run-in unit and 15-tooth cast or 30-tooth steel sprocket. Adjust chain tightener so there is approximately 3/4-inch of slack in the tight side of chain and secure tightener in this position.

NOTE: Move gear reducer sprocket in or out on reducer shaft so the sprocket lines up with the transmission's lower right sprocket.

Run-In Unit Assembly—Continued

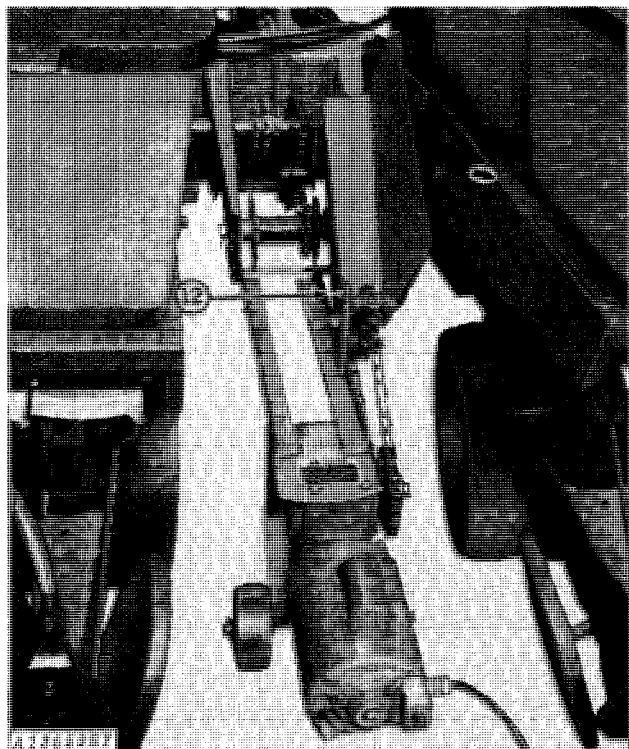

Fig. 7-Chain Shield Pivoted Back for Access to Chain and Idlers

12. Install chain shield with 3/8- x 3/4-inch cap screw and lock nut.

Tighten lock nut enough to hold shield securely in lowered or upright position, and still allow the shield to pivot.

CAUTION: Do not start motor until safety shield is in place. Keep shield in place while operating.

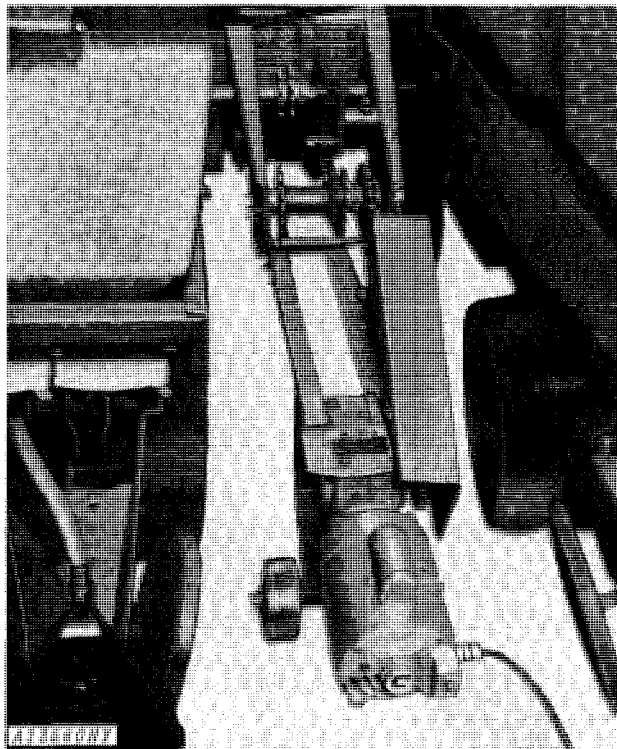

Fig. 8-Chain Shield in Operating Position

IMPORTANT: When running-in 12-row planter, disconnect one-half the planter drive by removing cotter pin from drill shaft and drive coupler. **DO NOT** run all 12 rows at one time since this may overload the run-in unit motor.

Do not move planter with run-in unit installed.

Run-In Procedure

Be certain planter is lowered to ground (planting position).

Check sprockets to be certain that they are aligned properly, and that chains are running straight.

Block planter wheels so planter will not move during run-in.

Plug run-in unit into a grounded 120 Volt outlet.

Lower chain shield to operating position and turn unit on.

Watch drive chains to be certain they are running smoothly on sprockets. Listen for any unusual noises. Check all drives to be sure they are not binding.

Examine seed meter parts, checking for any excessive wear.

DELIVERY SERVICE

A thorough discussion of the operation and service of a new planter at the time of delivery helps to assure complete customer satisfaction. Proper delivery should be an important phase of a dealer's program.

Many complaints arise simply because the owner is not shown how to operate, adjust and service the new planter properly. Enough time should be devoted, at the customer's convenience, to introducing the new planter and explaining how to operate, adjust, and service it.

Use the operator's manual as a guide to be sure the owner understands these points thoroughly.

1. The importance of safety.
2. The importance of lubrication and periodic service.
3. All planter functions and adjustments.
4. Transporting the planter.

AFTER-SALE INSPECTION

The purchaser of a new John Deere Planter is entitled to a free inspection by the dealer at some mutually agreeable time within the warranty period.

The purpose of this inspection is to make certain that the customer is receiving satisfactory performance from the planter. The inspection should reveal whether or not the planter is being operated, lubricated, and serviced properly.

With this recommended after-sale service inspection, you may eliminate needless service work by preventing minor irregularities from developing into serious problems later. This will promote strong dealer-customer relations and present you with an opportunity to answer questions that may have arisen.

Use this inspection period to acquaint the customer with any special attachments which will help him to do a better job with his machine.

Group 10 LUBRICATION

Effective use of lubricating oils and greases is perhaps the most important step towards low upkeep cost, long machine life, and satisfactory service.

Use only those lubricants specified in this section; apply them at the intervals and according to the instructions in the lubrication section.

ALL PLANTERS

SYMBOLS



Lubricate with John Deere Multi-Purpose Lubricant or an equivalent SAE multi-purpose-type grease at hourly intervals indicated on the symbols.



Lubricate with SAE 10 oil at hourly intervals indicated on the symbols.



Lubricate all roller chains periodically with John Deere PT508 chain lube or equivalent.

IMPORTANT: With plate type hoppers, sprinkle a teaspoon of powdered graphite (Part No. B33379) over the top of the seed twice a day. With plateless hoppers, use one teaspoon of powdered graphite each day. The graphite will filter down into the finger pickup mechanism or hopper bottom and insure proper lubrication. John Deere Graphite provides a dry lubrication. Some types have an oil base and will form a gummy residue on parts.

The graphite does not eliminate the need for proper and regular lubrication indicated in the lubrication charts.

NOTE: Any additives other than John Deere powdered graphite in finger pickup units may leave residue on parts.

NOTE: Repack wheel bearings once a year with wheel bearing grease.

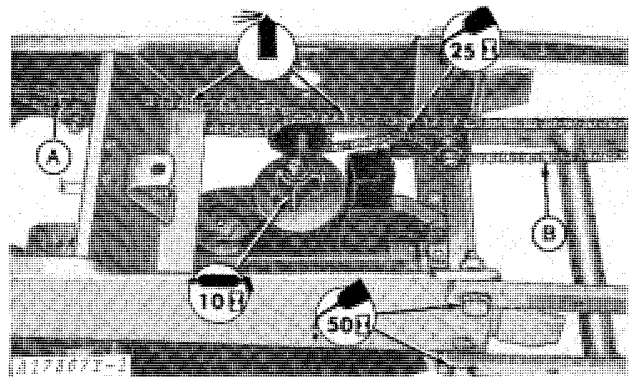

A—Insecticide and/or Herbicide Drive Chain

B—Planting Unit Drive Chain

Fig. 1-Unit Hopper Drive

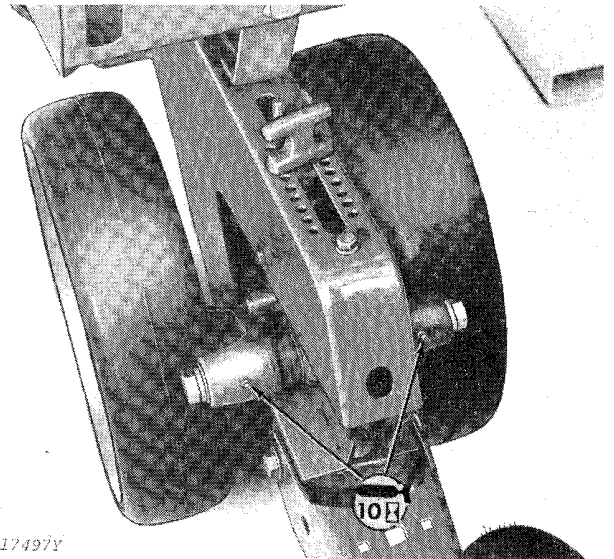

A17497Y

Fig. 2-Unit Gauge Wheels

7000 PLANTERS

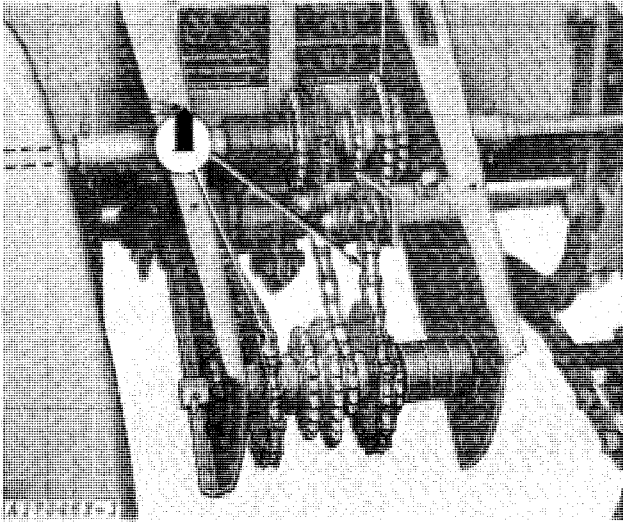

Fig. 3-Seed Drive

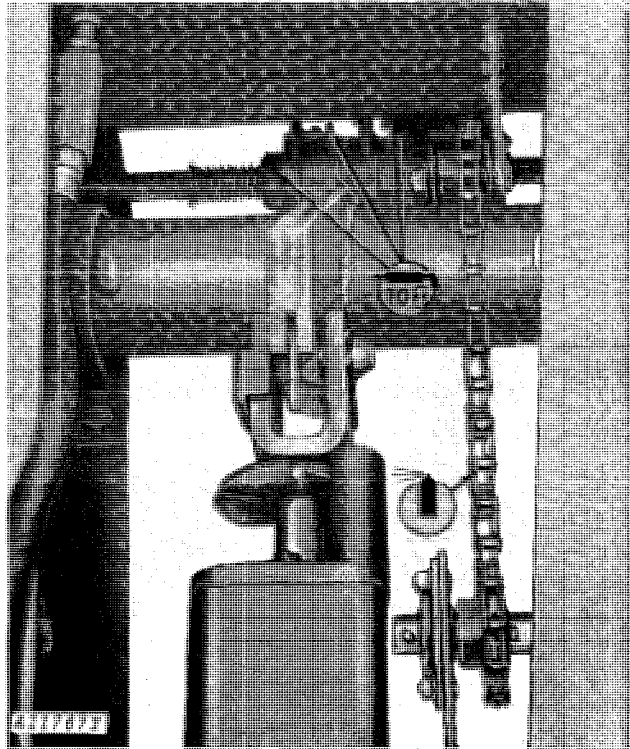

Fig. 5-Clutch and Countershaft Drive (4-Row Narrow, 4-Row Wide, 6-Row Narrow)

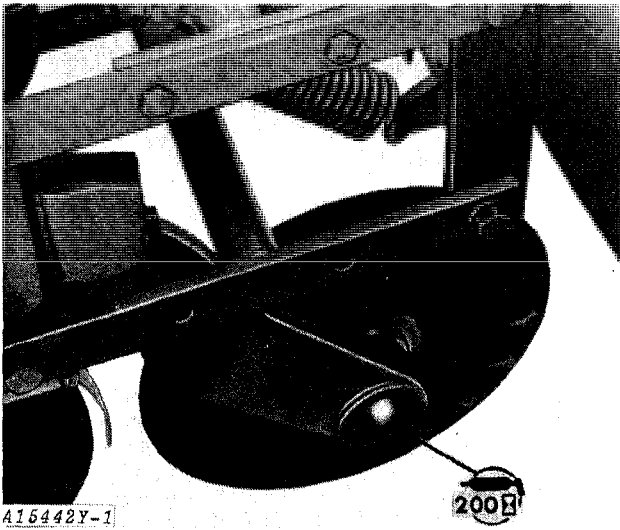

Fig. 4-Heavy-Duty Coultter

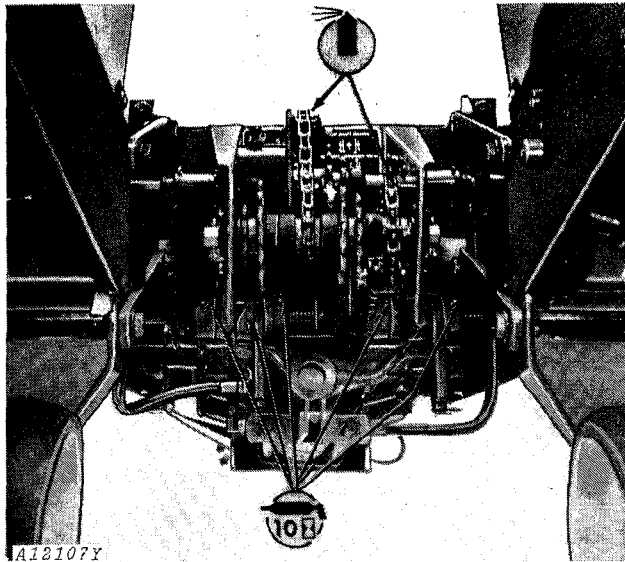

Fig. 6-Clutch and Countershaft Drive (6-Row Wide, 8- and 12-Row)

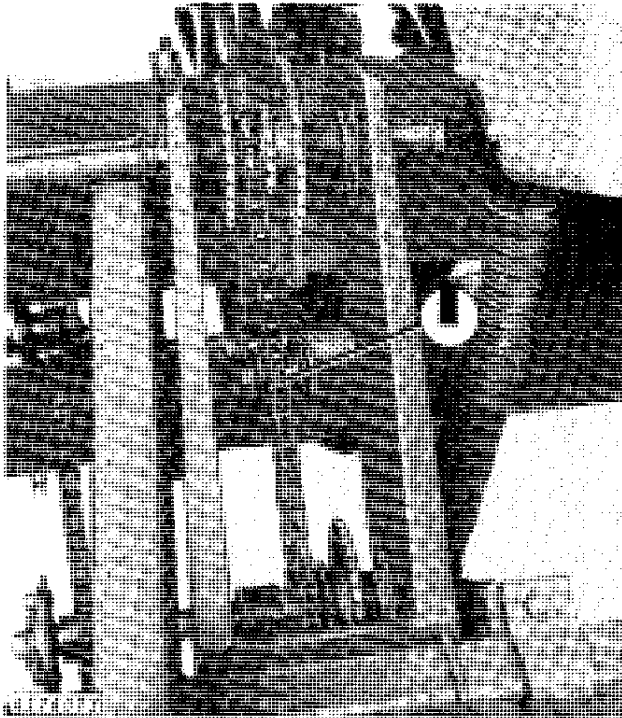

Fig. 7-Dry Fertilizer Transmission (4-Row Narrow, 4-Row Wide and 6-Row Narrow)

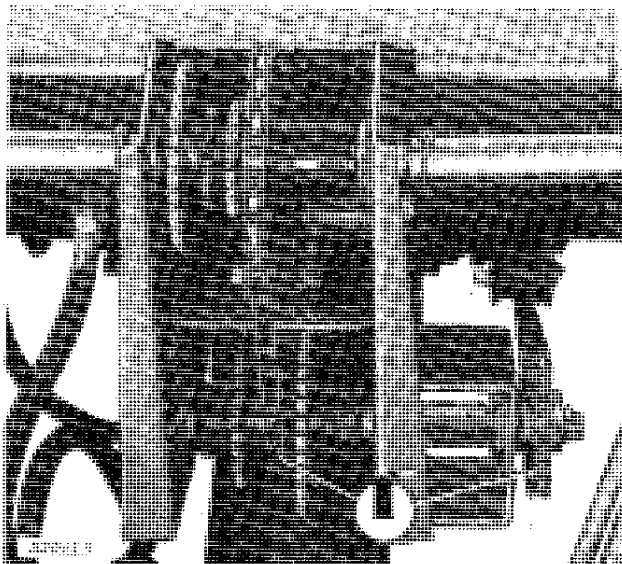

Fig. 8-Dry Fertilizer Transmission (6-Row Wide, 8- and 12-Row)

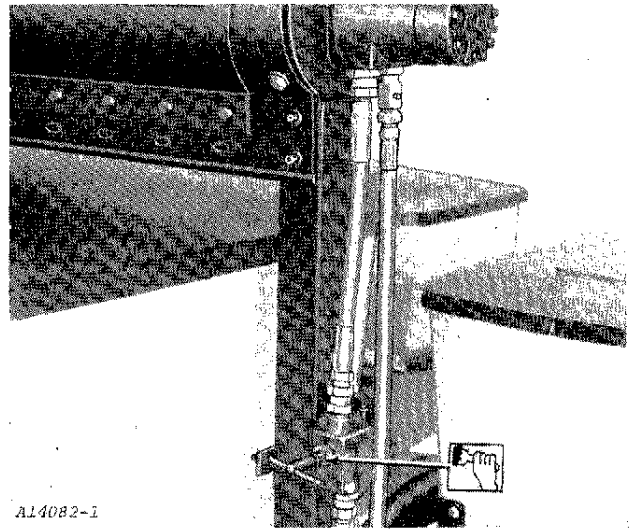

Fig. 9-Dry Fertilizer Auger Fill Safety Shutoff Valve

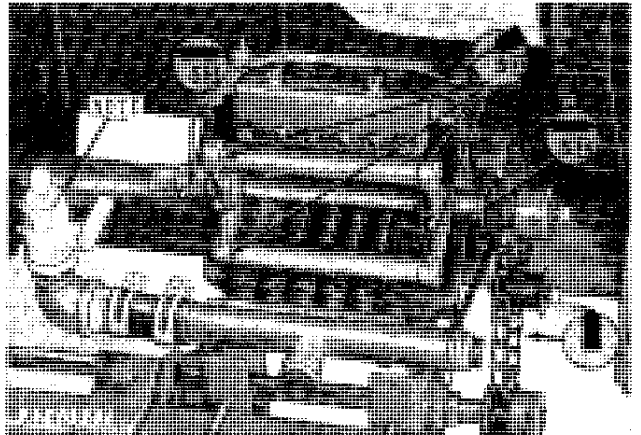

Fig. 10-4- and 6-Row Liquid Fertilizer Metering Pump

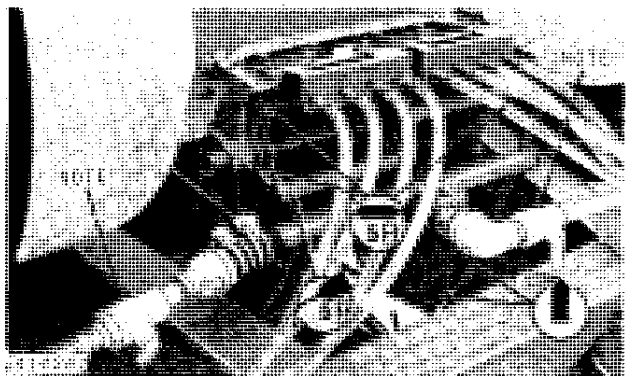

Fig. 11-8- and 12-Row Liquid Fertilizer Metering Pump

NOTE: (Fig. 10 and 11) Lubricate at the beginning and end of planting season.

Oil or repack bearing ends of squeeze roller to eliminate any remaining liquid fertilizer which would corrode the pump.